

VOLUMES

VOID RATIO: 95%
DISPLACEMENT VOL.: 4.50 CF
STORAGE VOL.: 4.28 CF

DIMENSIONS

LENGTH: 30.32"
WIDTH: 15.16"
HEIGHT: 16.93"

MATERIAL

100% RECYCLED POLYPROPYLENE

LOAD CAPACITY

VERTICAL RATING: 60 PSI
LATERAL RATING: 35 PSI
AASHTO LRFD: H-10
HS-20
HS-25

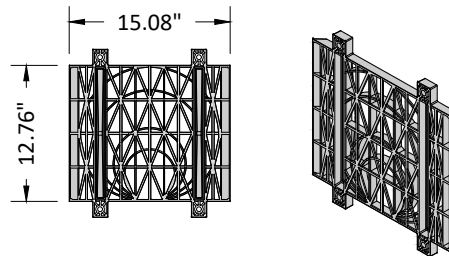

SIDE PLATE
TO BE INSTALLED ON THE
PERIMETER OF THE SYSTEM

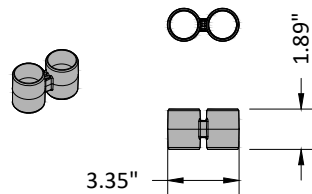

NOTE:
CONNECTOR LUGS TO BE USED TO JOIN
ADJACENT AND UPPER MODULES AS NEEDED.

CONNECTOR LUG
ENLARGED FOR CLARITY

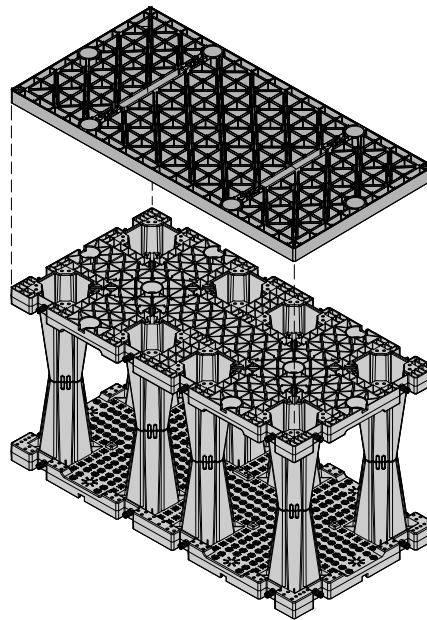

ISOMETRIC VIEW

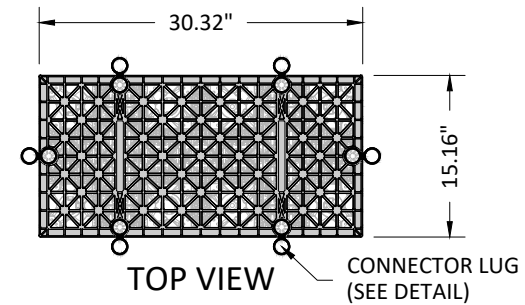

TOP VIEW

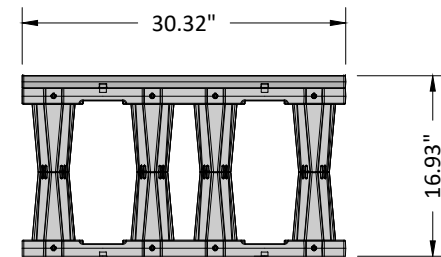

SIDE VIEW

RAINVAULT
UNDERGROUND DETENTION SYSTEM

Ripple Stormwater Technologies
FOR ADDITIONAL INFORMATION PLEASE CONTACT:
RIPPLE STORMWATER TECHNOLOGIES
804-400-9490 | WWW.RIPPLESTORMWATER.COM

RAINVAULT 1.0

REV. DATE
03/14/2024

NOT TO SCALE