

VOLUMES

VOID RATIO: 95%
 DISPLACEMENT VOL.: 12.88 CF
 STORAGE VOL.: 12.23 CF

DIMENSIONS

LENGTH: 30.32"
 WIDTH: 15.16"
 HEIGHT: 48.43"

MATERIAL

100% RECYCLED POLYPROPYLENE

LOAD CAPACITY

VERTICAL RATING: 60 PSI
 LATERAL RATING: 35 PSI
 AASHTO LRFD: H-10
 HS-20
 HS-25

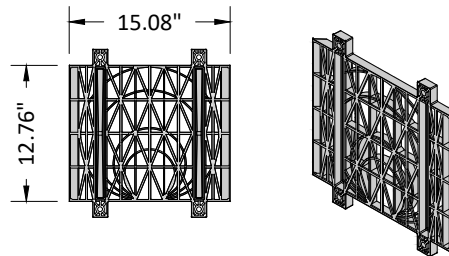

SIDE PLATE
 TO BE INSTALLED ON THE PERIMETER OF THE SYSTEM

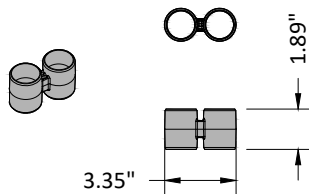

NOTE:
 CONNECTOR LUGS TO BE USED TO JOIN ADJACENT AND UPPER MODULES AS NEEDED.

CONNECTOR LUG
 ENLARGED FOR CLARITY

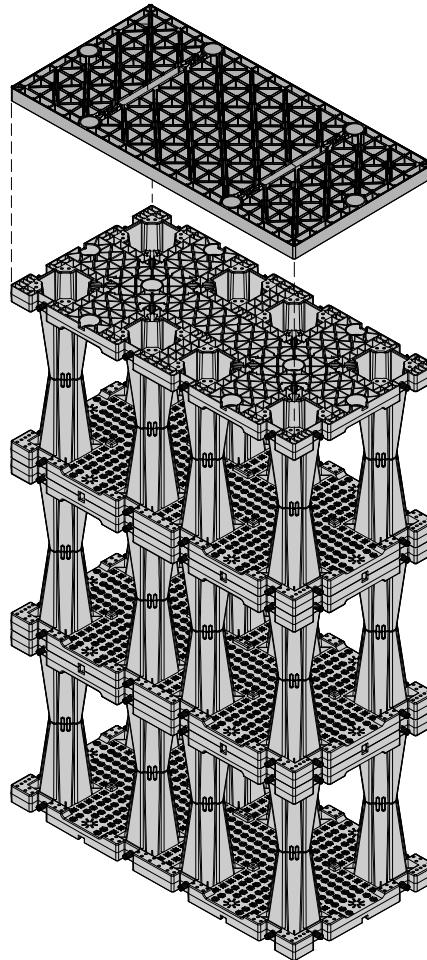

ISOMETRIC VIEW

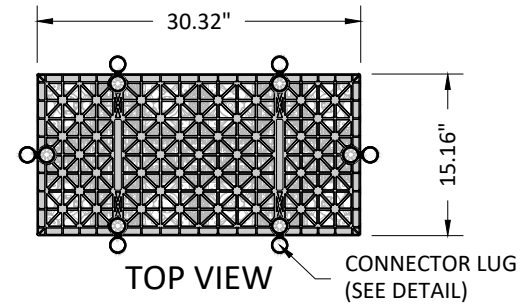

TOP VIEW

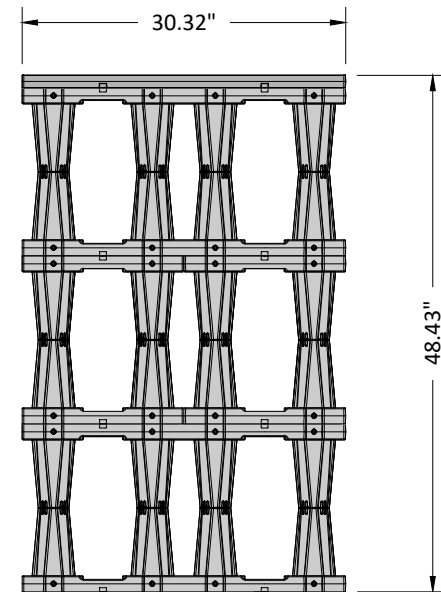

SIDE VIEW

RAINVAULT
 UNDERGROUND DETENTION SYSTEM

Ripple Stormwater Technologies
 FOR ADDITIONAL INFORMATION PLEASE CONTACT:
 RIPPLE STORMWATER TECHNOLOGIES
 804-400-9490 | WWW.RIPPLESTORMWATER.COM

RAINVAULT 3.0

REV. DATE
 03/14/2024

NOT TO SCALE